

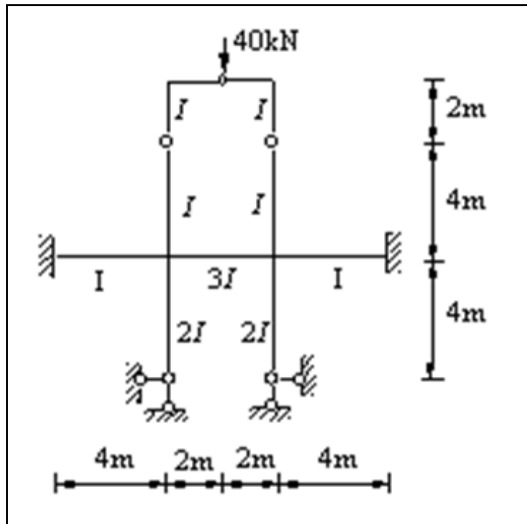

Question:



Answer

40kN·m (2分)

基本体系 (1分) \bar{M} 图 (1分)

M_p 图 (1分)

典型方程 $r_{11}Z_1 + R_{1P} = 0$, (2分)

$r_{11} = 16i$, (2分)

$R_{1P} = 80$, (2分)

$Z_1 = -\frac{5}{i}$ (2分)

M 图 (kN·m) (3分)



DinoSap Result

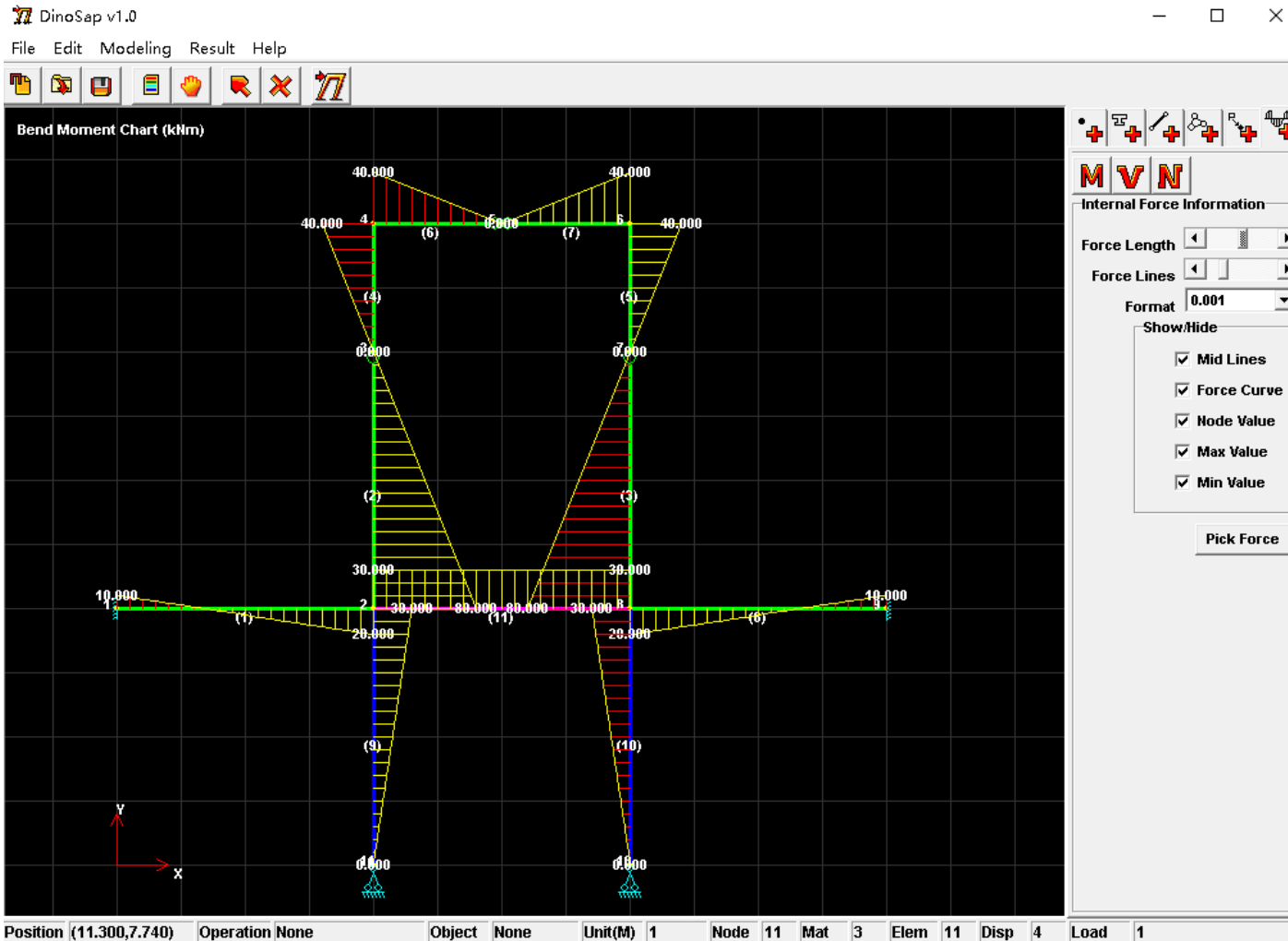



Question:

三、作图示结构的 M、Q 图。 $d=2\text{m}$ 。

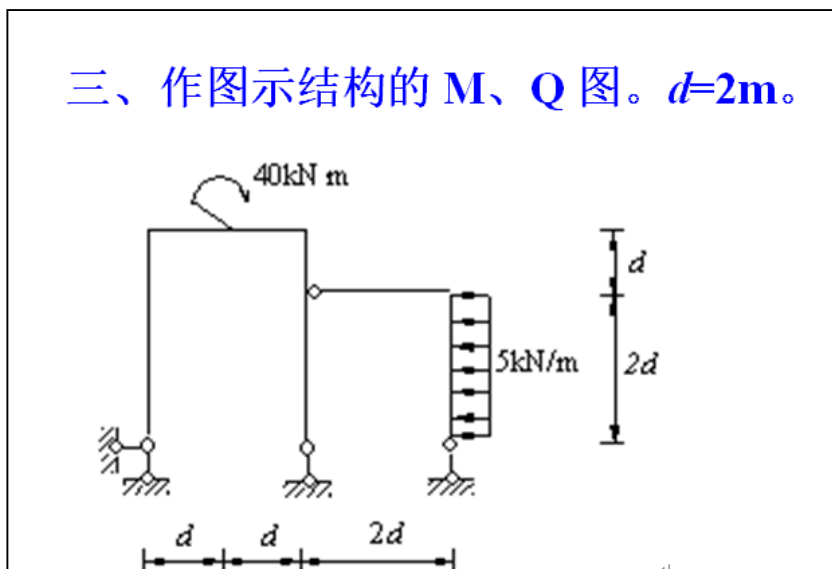

Answer

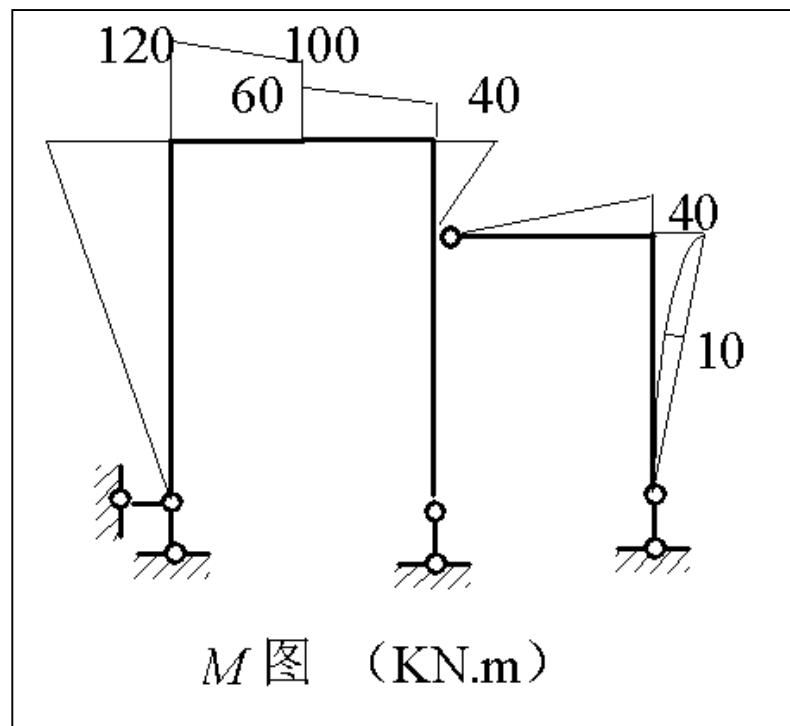



DinoSap Result

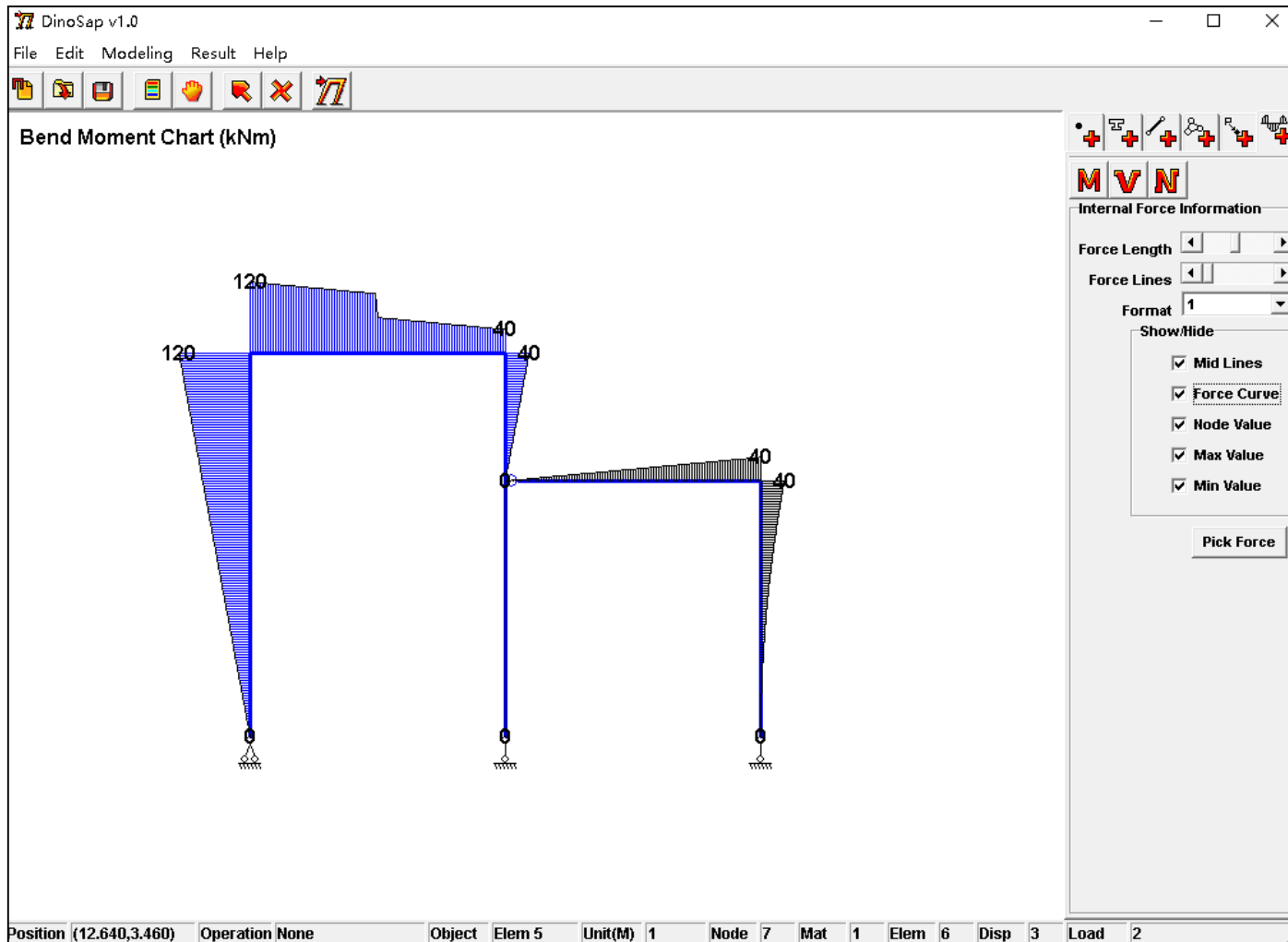

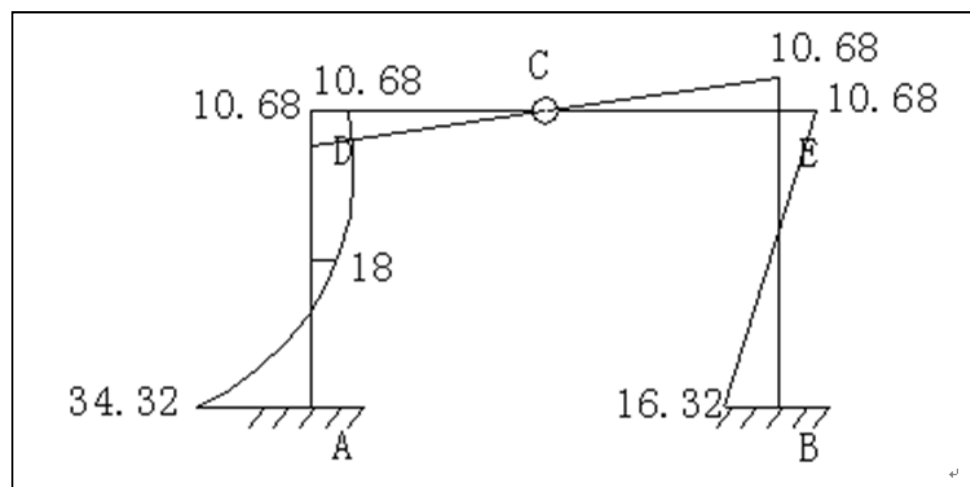
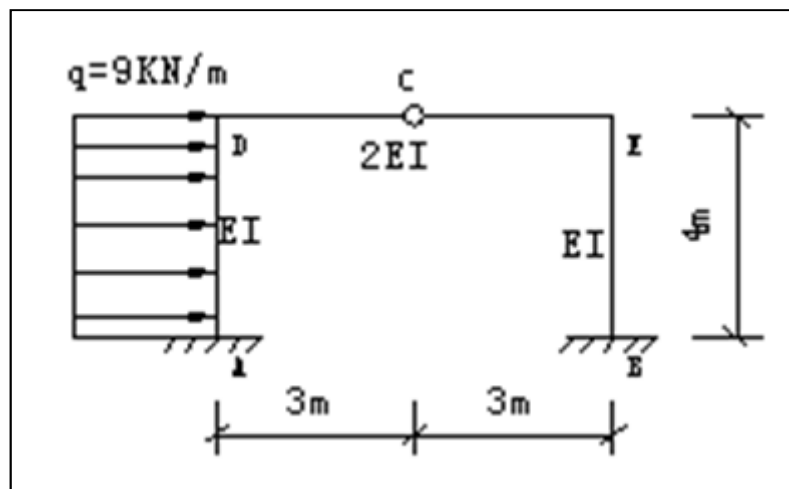



DinoSap Result

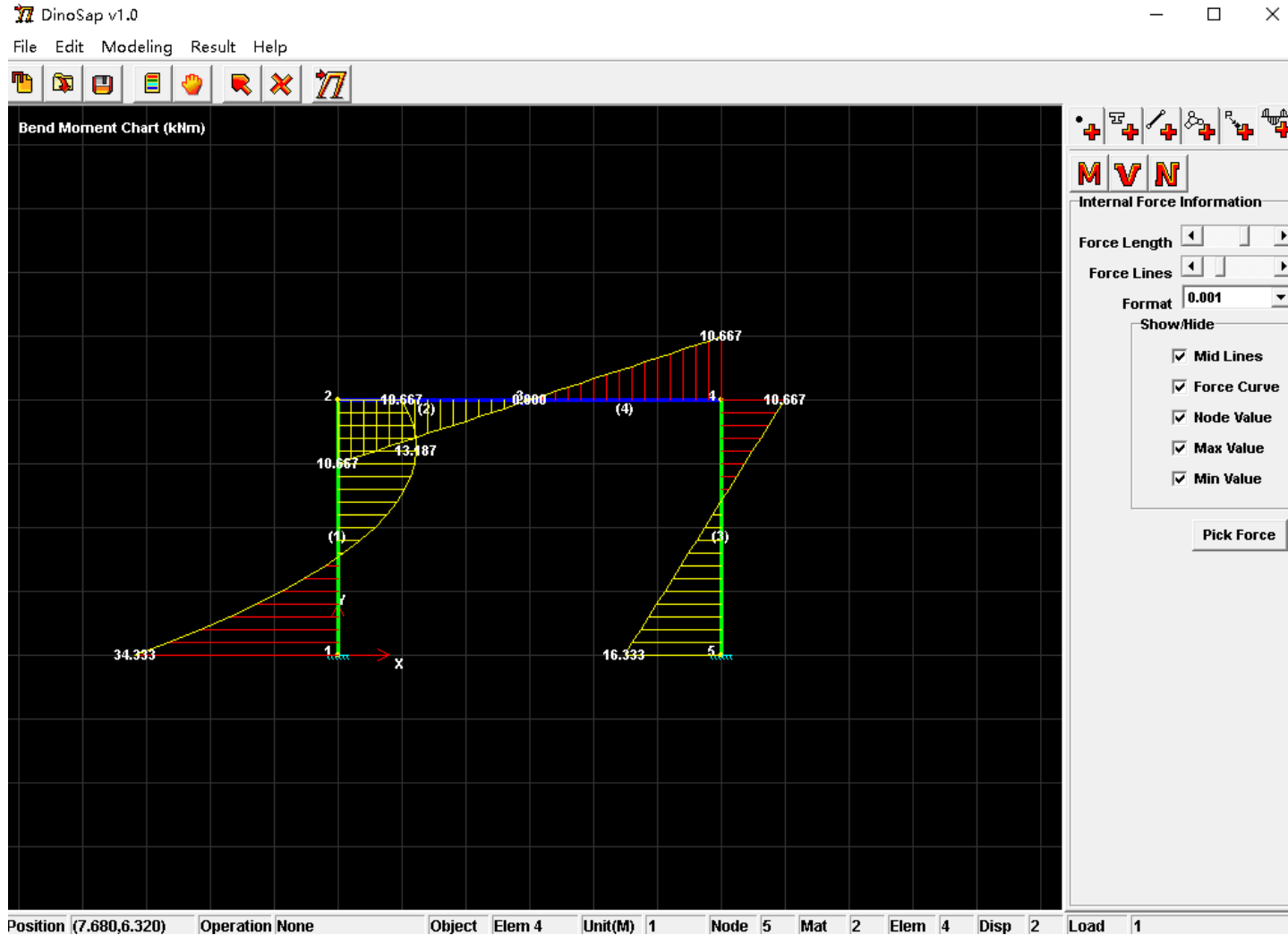

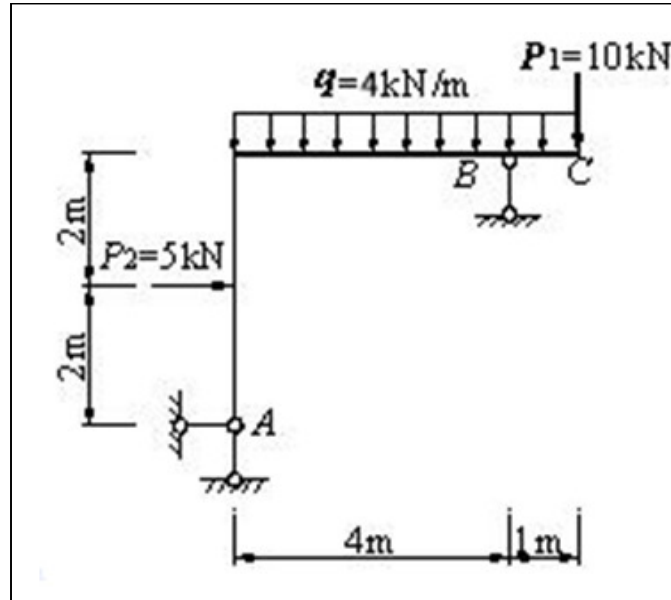

Answer

